



The quick start up/shutdown guide is not a substitute for reading the manual; the manual contains detailed information and instructions that you must be aware of and follow in order to maintain the equipment properly and use it safely. Remember to record the date of purchase and model number in your manual.



**WARNING!** Risk of eye injury. Spray could splash back or propel objects resulting in serious injury.

- Always wear indirect vented (chemical splash) safety goggles when using or near this product.
- Always wear protective clothing such as long-sleeved shirts, long pants and closed-toed shoes.

## Items Included:

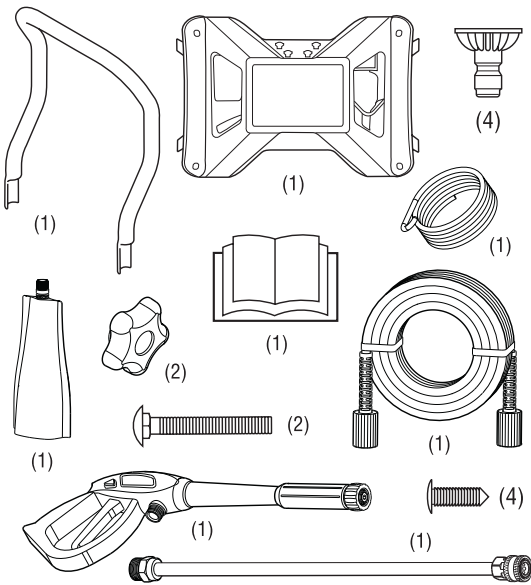

## Handle Attachment

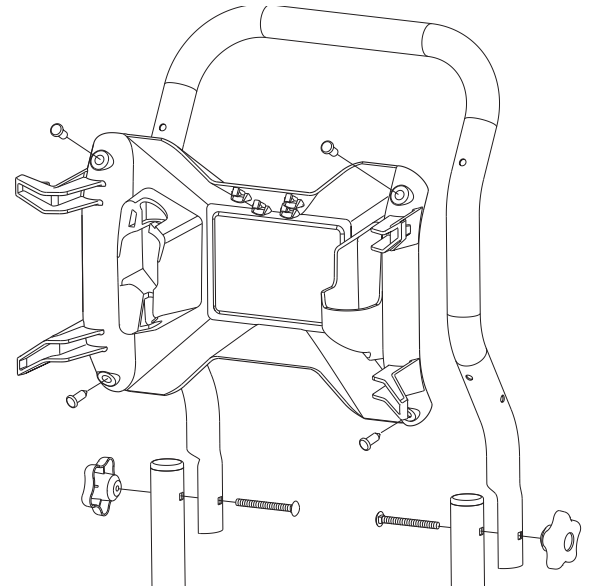

**Items needed:** (not included) • Grease • Garden hose, 50 ft. (15 m) or less • Safety goggles (indirect vented type)



## USE OUTDOORS - AVOID CARBON MONOXIDE POISONING - (SEE MANUAL)

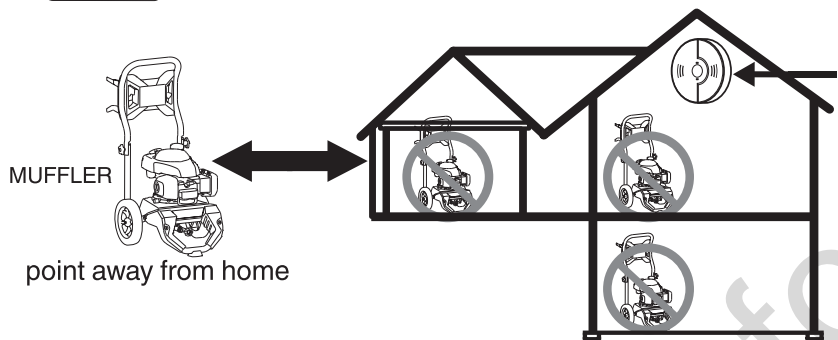

### CARBON MONOXIDE ALARM(S)

Install carbon monoxide alarms inside your home. Without working carbon monoxide alarms, you may not realize you are getting sick and dying from carbon monoxide poisoning.

## Start Up

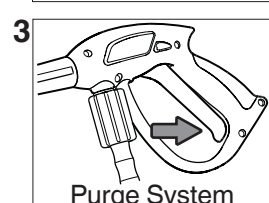
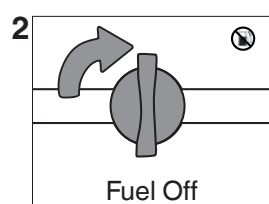
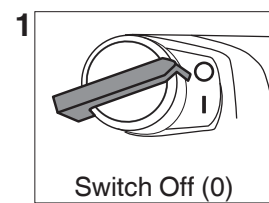
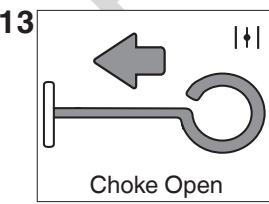
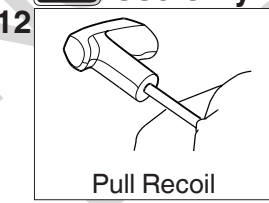
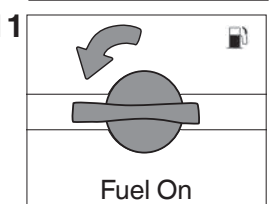
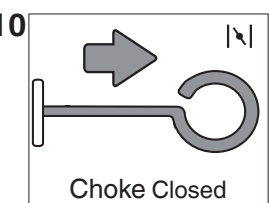
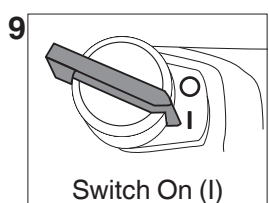
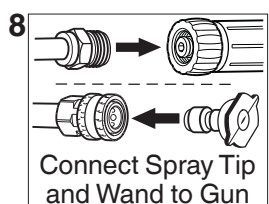
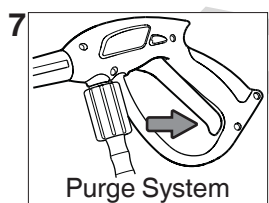
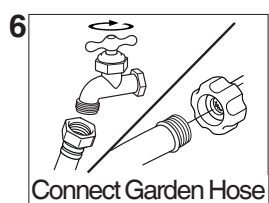
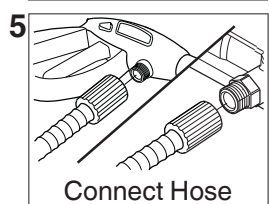
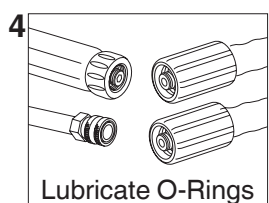
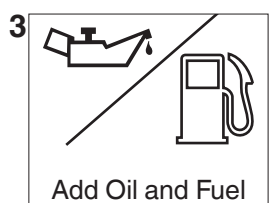

## Shutdown

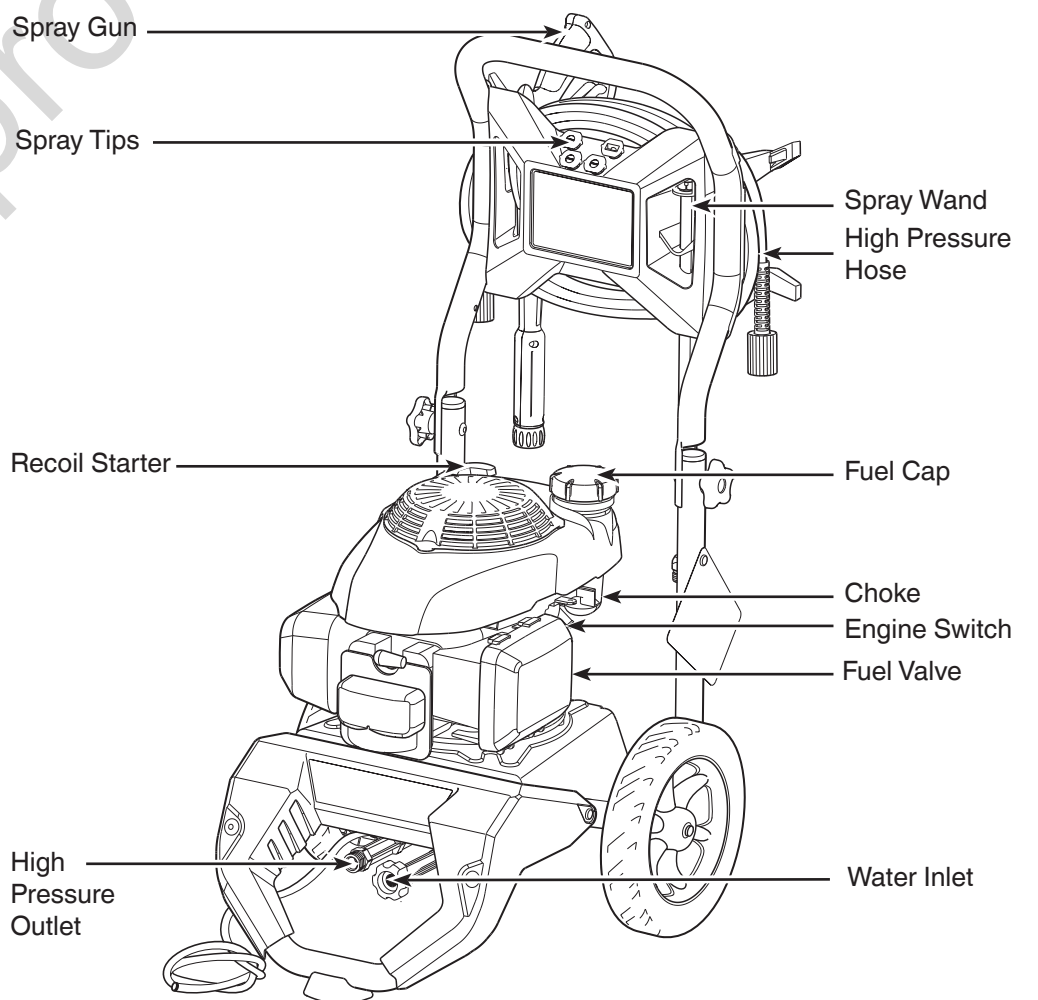

Copyright © 2019. All rights reserved. Briggs & Stratton Corporation. Milwaukee, WI, USA. POWERBOSS® is a registered trademark of Briggs & Stratton Corporation. No part of this material may be reproduced or transmitted in any form without the express written permission of Briggs & Stratton Corporation.

Every effort has been made to ensure that the information in this document is accurate and correct. However, we reserve the right to alter or otherwise improve the product and this document at any time without prior notice and without incurring obligation.

(800) 743-4115

powerboss-equipment.com



La guía rápida de arranque/apagado no sustituye la lectura del manual; el manual contiene información detallada e instrucciones que debe conocer y seguir para mantener el equipo en condiciones apropiadas y usarlo de manera segura. Recuerde registrar la fecha de compra y el número de modelo en su manual.



**¡ADVERTENCIA!** Riesgo de lesión ocular. El agua rociada podría salpicar o expulsar objetos, lo que puede resultar en lesiones graves.

- Siempre use gafas de seguridad con ventilación indirecta (salpicaduras de sustancias químicas) cuando utilice este producto o esté cerca del mismo. (Las gafas de seguridad no brindan una protección total).
- Siempre use ropa protectora como camisa de manga larga, pantalones largos y calzado cerrado.

## Elementos incluidos:

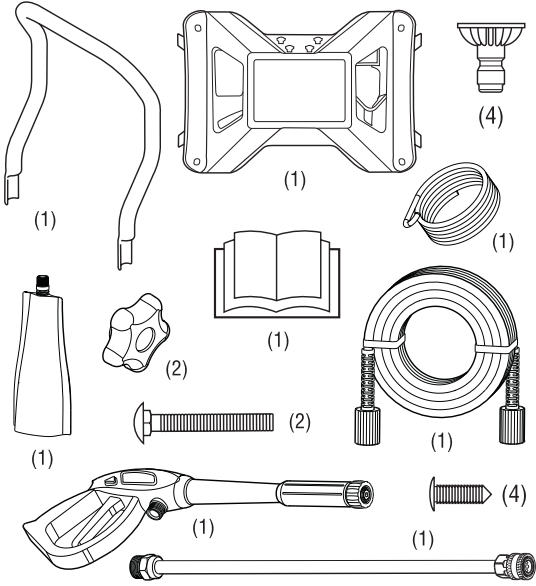

## Aditamento de mango

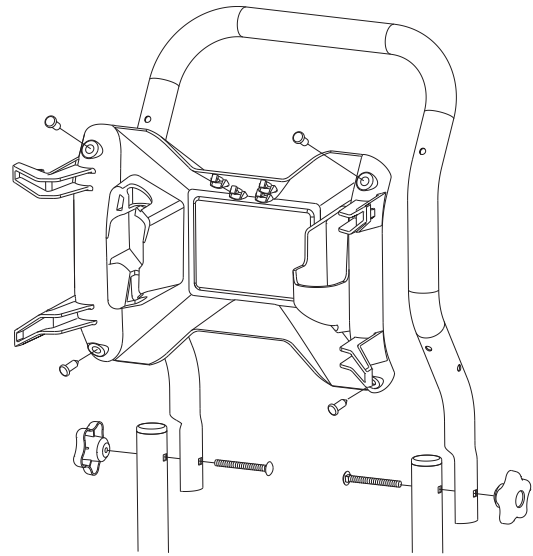

**Elementos necesarios:** (no incluidos) • Grasa • Manguera de jardín, 50 pies (15 m) o menos • Gafas de seguridad (tipo de ventilación indirecta)



## USE EN EXTERIORES - EVITE EL ENVENENAMIENTO POR MONÓXIDO DE CARBONO - (CONSULTE EL MANUAL)

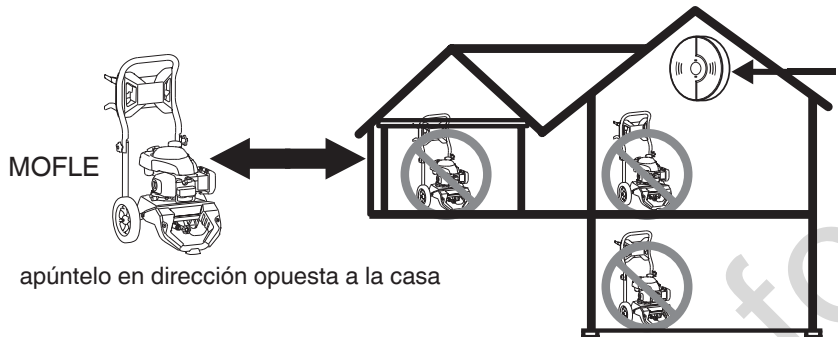

### ALARMA(S) DE MONÓXIDO DE CARBONO

Instale alarmas de monóxido de carbono en el interior de su casa. Sin alarmas de monóxido de carbono en funcionamiento, es posible que no se dé cuenta de que se está intoxicando y muriendo debido a una intoxicación por monóxido de carbono.

## Arranque

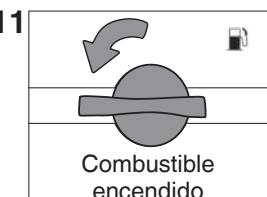
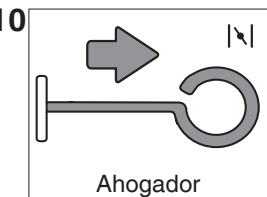
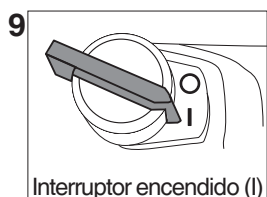
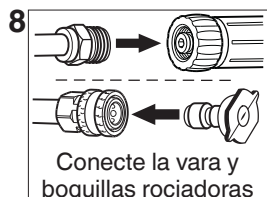
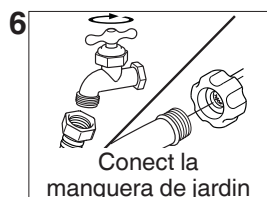
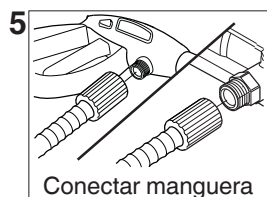
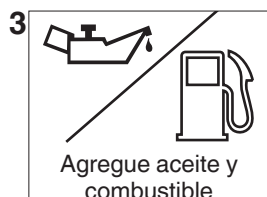
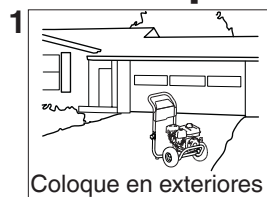

### Sólo para uso en exteriores

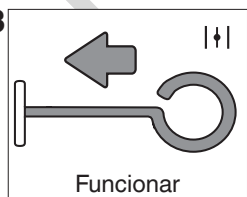

## Apagado

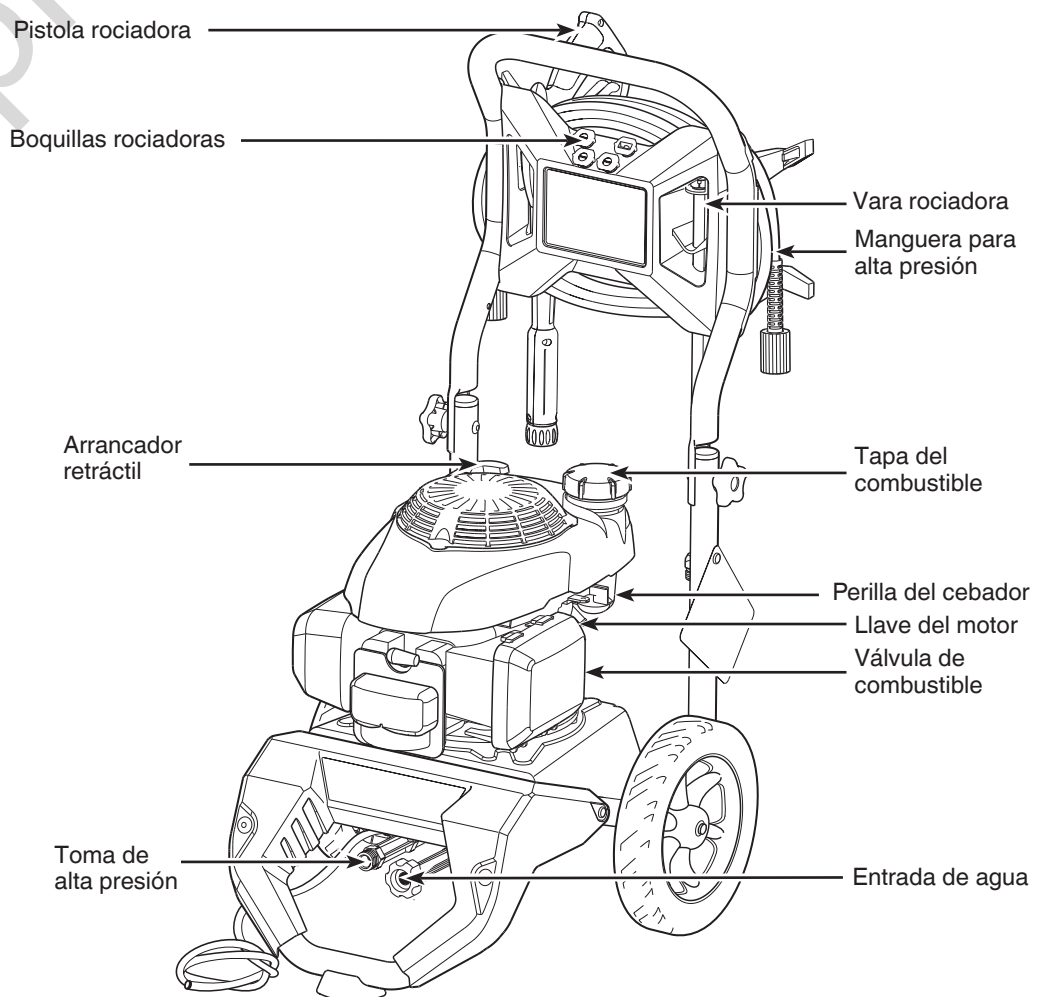
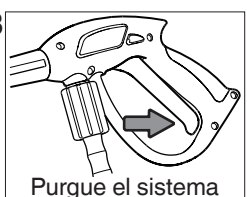
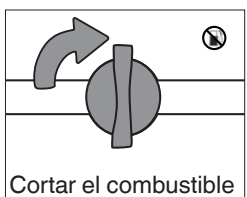
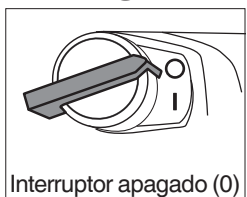

Copyright © 2019. Reservados todos los derechos. Briggs & Stratton Corporation. Milwaukee, WI, USA. POWERBOSS® es una marca registrada de Briggs & Stratton Corporation. Queda prohibida la reproducción o transmisión total o parcial de este material, sin el permiso previo y por escrito de Briggs & Stratton Corporation.

Se ha realizado el máximo esfuerzo para reunir en este manual la información más precisa y actualizada. No obstante, nos reservamos el derecho de modificar o mejorar de cualquier otra forma el producto y este documento en cualquier momento y sin previo aviso, y sin incurrir en ninguna obligación.

(800) 743-4115

powerboss-equipment.com